

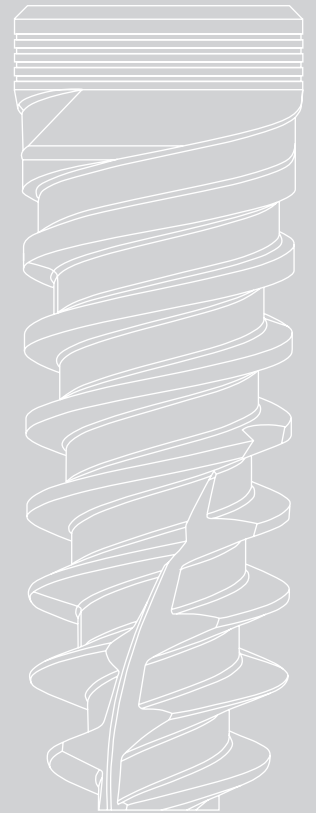

Smarter Thinking. Simpler Design.



Prima Plus™

Product Catalog



Prima Plus™

| | |
|-----------------------------------------|----|
| Ø3.5 mm Prima Plus™ Implants | 4 |
| Ø3.5 mm Prosthetic Options | 5 |
| Ø3.5 mm Prosthetic Components | 6 |
| Ø4.1 mm Prima Plus™ Implants | 10 |
| Ø4.1 mm Prosthetic Options | 11 |
| Ø4.1 mm Prosthetic Components | 12 |
| Ø5.0/6.0 mm Prima Plus™ Implants | 16 |
| Ø5.0/6.0 mm Prosthetic Options | 17 |
| Ø5.0/6.0 mm Prosthetic Components | 18 |

Digital

| | |
|---------------------------------|----|
| Imagine™ Milling Services | 23 |
| Core3dcentres® | 26 |
| In-Office Milling | 28 |

LOCATOR® Abutments

| | |
|-----------------------------------|----|
| LOCATOR® Prosthetic Options | 30 |
| LOCATOR® Abutment | 31 |
| LOCATOR® R-Tx™ Abutment | 32 |
| LOCATOR® F-Tx™ Abutment | 33 |

Surgical Kit & Instruments

| | |
|--------------------------------|----|
| Prima Plus™ Surgical Kit | 35 |
| Prima Plus™ Instruments | 36 |

Surgical Motors & Accessories

| | |
|----------------------------------|----|
| Surgical Motors | 40 |
| Surgical Motor Accessories | 42 |

| | |
|--------------------------|----|
| Terms & Conditions | 43 |
|--------------------------|----|

Product specifications are subject to change without notice.
Items illustrated are not to scale.



Prima Plus™ Implants



Catalog #

- 15730K**
- 15731K**
- 15732K**
- 15733K**
- 15734K**

Implant Size

- Ø3.5 x 8 mm Length*
- Ø3.5 x 10 mm Length
- Ø3.5 x 11.5 mm Length
- Ø3.5 x 13 mm Length
- Ø3.5 x 15 mm Length

Cover Screw



Catalog #

- 15300K**

Description

- Ø3.5 mm

Healing Abutments



Catalog #

- 15301K**
- 15302K**
- 15303K**

- 15317K**
- 15318K**

- 15304K**
- 15305K**

Description

- Ø3.5 mm
- Ø3.5 mm
- Ø3.5 mm

- Ø3.5 mm
- Ø3.5 mm

- Ø3.5 mm
- Ø3.5 mm

Flare

- Straight
- Straight
- Straight

- 4.0 mm
- 4.0 mm

- 5.0 mm
- 5.0 mm

Cuff Height

- 3.0 mm
- 5.0 mm
- 7.0 mm

- 3.0 mm
- 5.0 mm

- 3.0 mm
- 5.0 mm

The Ø3.5 mm Prima Plus™ can be restored with straight, Ø4.0 and Ø5.0 mm flared prosthetic components. An Abutment Screw is included with all TiLobe® abutments.



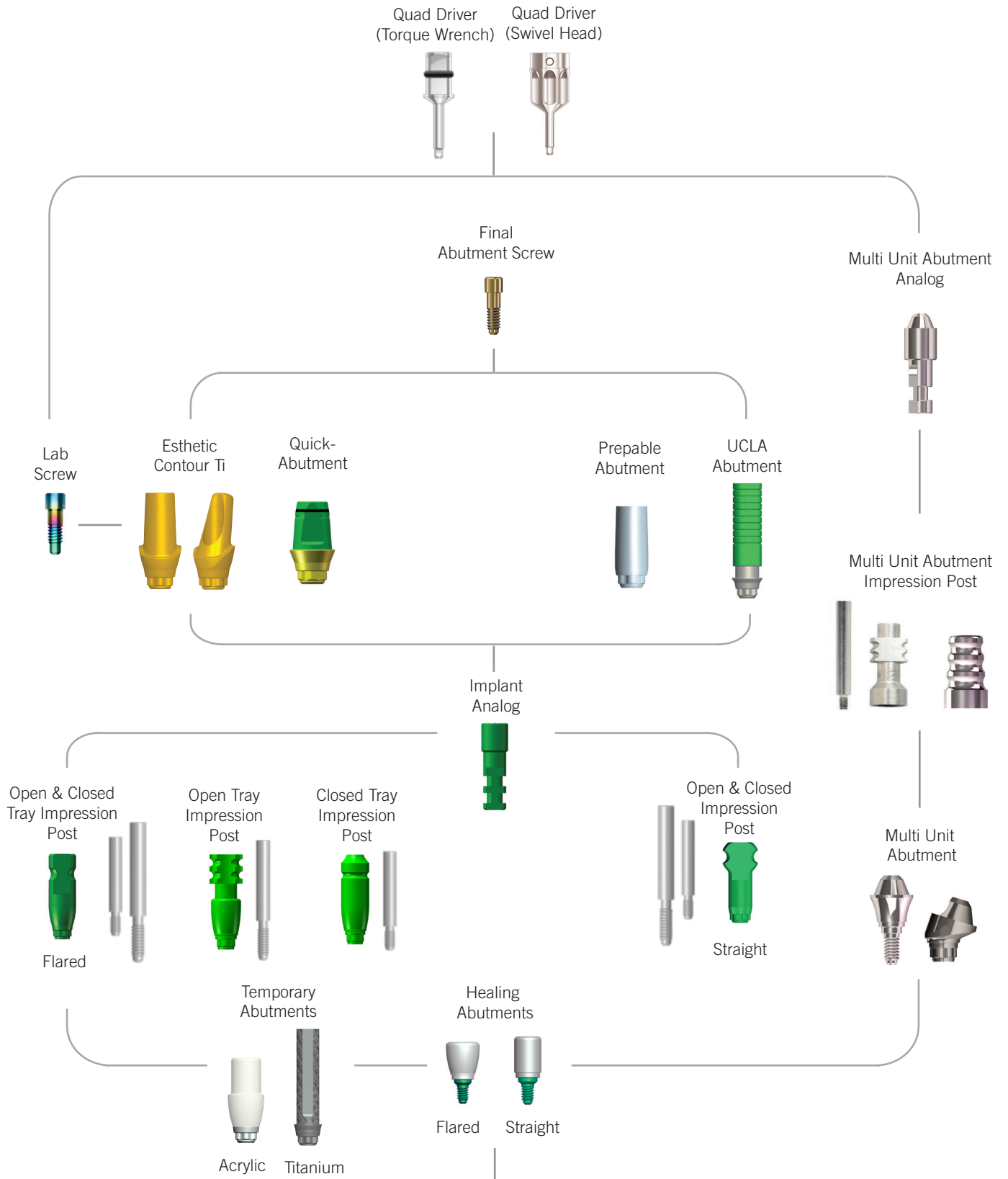





*Not recommended to be used as a free standing implant.











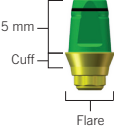

Prosthetic Components

Internal TiLobe®

| | Catalog # | Description | Flare | Cuff Height |
|----------------------------------------------------------------------------------------------------------------------------------------------------|---------------|----------------------------------|----------|-------------|
| Open & Closed Tray Impression Post  | 45130K | Ø3.5 mm | Straight | |
| | 45136K | Ø3.5 mm | 4.0 mm | |
| | 45131K | Ø3.5 mm | 5.0 mm | |
| Open Tray Impression Post  | 45904K | Ø3.5 mm | 4.0 mm | |
| | 45906K | Ø3.5 mm | 5.0 mm | |
| Closed Tray Impression Post  | 45905K | Ø3.5 mm | 4.0 mm | |
| | 45907K | Ø3.5 mm | 5.0 mm | |
| Implant Analog  | 45140K | Ø3.5 mm, 1-Pack | | |
| | 45143K | Ø3.5 mm, 10-Pack | | |
| Temporary Abutment  | 45118K | Ø3.5 mm, Locking | 4.0 mm | |
| | 45119K | Ø3.5 mm, Non-Locking | 4.0 mm | |
| | 45112K | Ø3.5 mm, Locking | 5.0 mm | |
| Ti Temporary Abutment  | 45075K | Ø3.5 mm, Locking | | |
| | 45076K | Ø3.5 mm, Non-Locking | | |
| Esthetic Contour Ti Abutment  Cuff Height (Buccal) | 45046K | Ø3.5 mm, Straight | 4.0 mm | 1.0 mm |
| | 45047K | Ø3.5 mm, Straight | 4.0 mm | 2.0 mm |
| | 45048K | Ø3.5 mm, 15° Angled | 4.0 mm | 1.0 mm |
| | 45049K | Ø3.5 mm, 15° Angled | 4.0 mm | 2.0 mm |
| | 45030K | Ø3.5 mm, Straight | 5.0 mm | 1.0 mm |
| | 45031K | Ø3.5 mm, Straight | 5.0 mm | 3.0 mm |
| | 45032K | Ø3.5 mm, 15° Angled | 5.0 mm | 1.0 mm |
| | 45033K | Ø3.5 mm, 15° Angled | 5.0 mm | 3.0 mm |
| | 45033K | Ø3.5 mm, 15° Angled | 5.0 mm | 3.0 mm |
| UCLA Abutment  | 45100K | Gold/Plastic Sleeve, Locking | | 1.0 mm |
| | 45101K | Gold/Plastic Sleeve, Non-Locking | | 1.0 mm |

| | | | | | |
|---------------------------------------------|-------------------------------------------------------------------------------------|------------------|----------------------|--------------|--------------------|
| Replacement Final Abutment Screw |  | <i>Catalog #</i> | <i>Description</i> | | |
| | | 45060K | 1-Pack | | |
| Laboratory Screw |  | <i>Catalog #</i> | <i>Description</i> | | |
| | | 45061K | 10-Pack | | |
| Quick-Packs |  | <i>Catalog #</i> | <i>Description</i> | <i>Flare</i> | <i>Cuff Height</i> |
| | | 45400K | Ø3.5 mm | 5.0 mm | 1.0 mm |
| | | 45401K | Ø3.5 mm | 5.0 mm | 2.0 mm |
| | | 45402K | Ø3.5 mm | 5.0 mm | 3.0 mm |
| | | 45403K | Ø3.5 mm | 5.0 mm | 4.0 mm |
| Quick-Abutment |  | <i>Catalog #</i> | <i>Description</i> | <i>Flare</i> | <i>Cuff Height</i> |
| | | 45420K | Ø3.5 mm | 5.0 mm | 1.0 mm |
| | | 45421K | Ø3.5 mm | 5.0 mm | 2.0 mm |
| | | 45422K | Ø3.5 mm | 5.0 mm | 3.0 mm |
| | | 45423K | Ø3.5 mm | 5.0 mm | 4.0 mm |
| Quick-Abutment Quick-Cap® |  | <i>Catalog #</i> | <i>Description</i> | <i>Flare</i> | |
| | | 45432K | Ø3.5 mm, 1-Pack | 5.0 mm | |
| Quick-Abutment Temporary/Healing Cap |  | <i>Catalog #</i> | <i>Description</i> | <i>Flare</i> | |
| | | 45209K | Ø3.5 mm | 5.0 mm | |
| Quick-Abutment Analog |  | <i>Catalog #</i> | <i>Description</i> | <i>Flare</i> | |
| | | 45445K | Ø3.5 mm | 5.0 mm | |
| Quick-Abutment Plastic Sleeve |  | <i>Catalog #</i> | <i>Description</i> | <i>Flare</i> | |
| | | 45215K | Ø3.5 mm, Locking | 5.0 mm | |
| | | 45218K | Ø3.5 mm, Non-Locking | 5.0 mm | |
| Quick-Abutment Ceramic Coping |  | <i>Catalog #</i> | <i>Description</i> | <i>Flare</i> | |
| | | 45301K | Ø3.5 mm | 5.0 mm | |



Prosthetic Components

Internal TiLobe®

Quick-Abutment Plastic Sleeve Reamer Tool

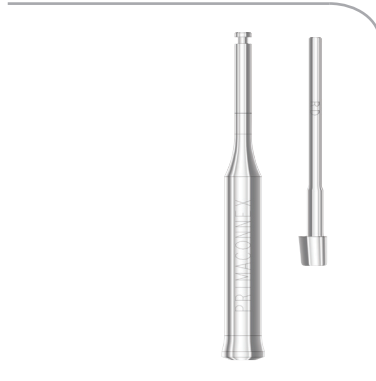

Catalog #

45311K

Description

Reamer Tool and Centering Pins

Prepable Abutment



Catalog #

45042K

Description

Ø3.5 mm

Multi Unit Abutment

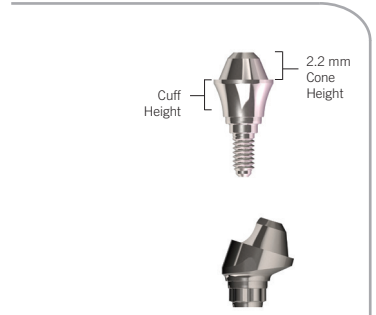

Catalog #

45312K

45313K

45314K

45321K

45322K

45936K

45937K

45938K

Description

Ø3.5 mm, Straight

Ø3.5 mm, Straight

Ø3.5 mm, Straight

Ø3.5 mm, Angled, 17°

Ø3.5 mm, Angled, 17°

Ø3.5/3.8 mm, Angled, 30°

Ø3.5/3.8 mm, Angled, 30°

Ø3.5/3.8 mm, Angled, 30°

Cuff Height

1.0 mm

2.0 mm

3.0 mm

3.0 mm

4.0 mm

3.0 mm

4.0 mm

5.0 mm

Multi Unit Abutment Healing Cap



Catalog #

45330K

Description

Ø3.5 mm

**Multi Unit Abutment
Impression Post**



Catalog #

Description

45327K
45328K

Open Tray, Ø3.5 mm with screw
Closed Tray, Ø3.5 mm

**Multi Unit Abutment
Analog**



Catalog #

Description

45329K

Ø3.5mm

**Multi-Unit Abutment
Ti Temporary Sleeve**

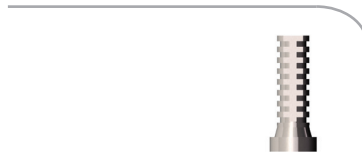

Catalog #

Description

45331K

Ø3.5 mm

**Multi Unit Abutment
Plastic Sleeve**

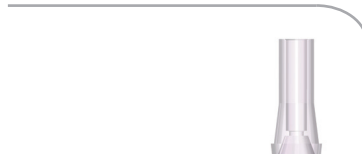

Catalog #

Description

45332K

Ø3.5 mm

**Multi Unit Abutment
Prosthetic Screw**



Catalog #

Description

45333K

1-Pack

**Angled Multi-Unit Abutment
Replacement Screw**

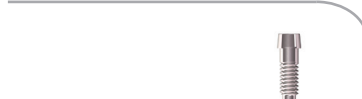

Catalog #

Description

45334K

1-Pack

Prima Plus™ Implants



Catalog #

- 15735K**
- 15736K**
- 15737K**
- 15738K**
- 15739K**

Implant Size

- Ø4.1 x 8 mm Length
- Ø4.1 x 10 mm Length
- Ø4.1 x 11.5 mm Length
- Ø4.1 x 13 mm Length
- Ø4.1 x 15 mm Length

Cover Screw



Catalog #

- 15306K**

Description

Ø4.1 mm

Healing Abutments



Catalog #

- 15307K**
- 15308K**
- 15309K**
- 15319K**
- 15320K**
- 15310K**
- 15311K**

Description

- Ø4.1 mm
- Ø4.1 mm
- Ø4.1 mm
- Ø4.1 mm
- Ø4.1 mm
- Ø4.1 mm
- Ø4.1 mm

Flare

- Straight
- Straight
- Straight
- 5.0 mm
- 5.0 mm
- 6.0 mm
- 6.0 mm

Cuff Height

- 3.0 mm
- 5.0 mm
- 7.0 mm
- 3.0 mm
- 5.0 mm
- 3.0 mm
- 5.0 mm

The Ø4.1 mm Prima Plus™ can be restored with straight, Ø5.0 and Ø6.0 mm flared prosthetic components. An Abutment Screw is included with all TiLobe® abutments.

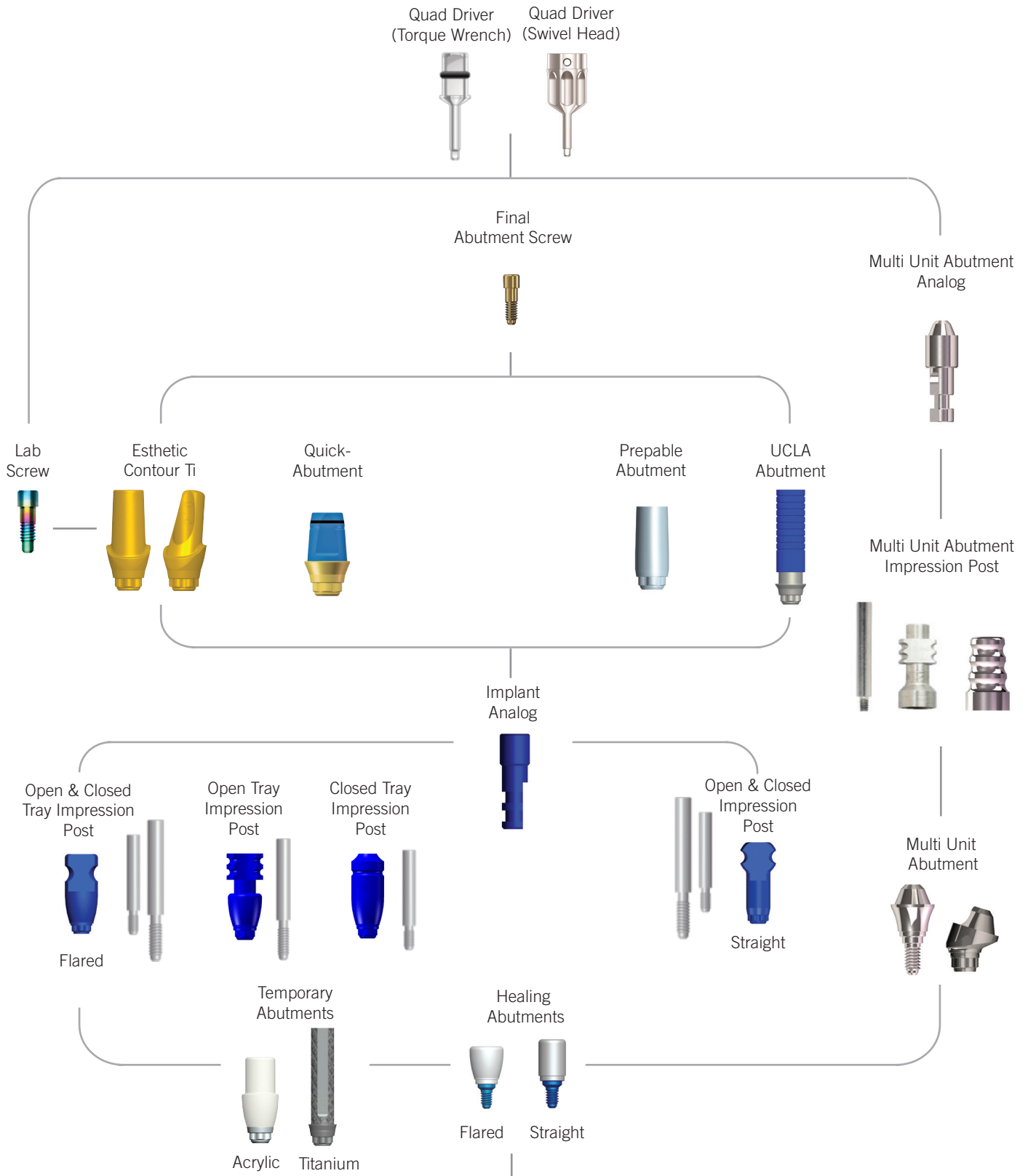

Open & Closed Tray Impression Post



| Catalog # | Description | Flare |
|-----------|-------------|----------|
| 45132K | Ø4.1 mm | Straight |
| 45137K | Ø4.1 mm | 5.0 mm |
| 45133K | Ø4.1 mm | 6.0 mm |

Open Tray Impression Post



| Catalog # | Description | Flare |
|-----------|-------------|--------|
| 45908K | Ø4.1 mm | 5.0 mm |
| 45910K | Ø4.1 mm | 6.0 mm |

Closed Tray Impression Post



| Catalog # | Description | Flare |
|-----------|-------------|--------|
| 45909K | Ø4.1mm | 5.0 mm |
| 45911K | Ø4.1 mm | 6.0 mm |

Implant Analog



| Catalog # | Description |
|-----------|------------------|
| 45141K | Ø4.1 mm, 1-Pack |
| 45144K | Ø4.1 mm, 10-Pack |

Temporary Abutment



| Catalog # | Description | Flare |
|-----------|----------------------|--------|
| 45120K | Ø4.1 mm, Locking | 5.0 mm |
| 45121K | Ø4.1 mm, Non-Locking | 5.0 mm |
| 45114K | Ø4.1 mm, Locking | 6.0 mm |

Ti Temporary Abutment



| Catalog # | Description |
|-----------|----------------------|
| 45077K | Ø4.1 mm, Locking |
| 45078K | Ø4.1 mm, Non-Locking |

Esthetic Contour Ti Abutment

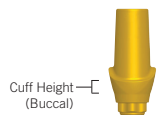

| Catalog # | Description | Flare | Cuff Height |
|-----------|---------------------|--------|-------------|
| 45050K | Ø4.1 mm, Straight | 5.0 mm | 0.5 mm |
| 45051K | Ø4.1 mm, Straight | 5.0 mm | 1.5 mm |
| 45052K | Ø4.1 mm, 15° Angled | 5.0 mm | 0.5 mm |
| 45053K | Ø4.1 mm, 15° Angled | 5.0 mm | 1.5 mm |
| 45034K | Ø4.1 mm, Straight | 6.0 mm | 1.0 mm |
| 45035K | Ø4.1 mm, Straight | 6.0 mm | 3.0 mm |
| 45036K | Ø4.1 mm, 15° Angled | 6.0 mm | 1.0 mm |
| 45037K | Ø4.1 mm, 15° Angled | 6.0 mm | 3.0 mm |

UCLA Abutment



| Catalog # | Description | Cuff Height |
|-----------|----------------------------------|-------------|
| 45102K | Gold/Plastic Sleeve, Locking | 1.0 mm |
| 45103K | Gold/Plastic Sleeve, Non-Locking | 1.0 mm |

**Replacement
Final Abutment Screw**



| <i>Catalog #</i> | <i>Description</i> |
|------------------|--------------------|
| 45060K | 1-Pack |

Laboratory Screw



| <i>Catalog #</i> | <i>Description</i> |
|------------------|--------------------|
| 45061K | 10-Pack |

Quick-Packs



| <i>Catalog #</i> | <i>Description</i> | <i>Flare</i> | <i>Cuff Height</i> |
|------------------|--------------------|--------------|--------------------|
| 45412K | Ø4.1 mm | 5.0 mm | 0.5 mm |
| 45413K | Ø4.1 mm | 5.0 mm | 1.5 mm |
| 45414K | Ø4.1 mm | 5.0 mm | 2.5 mm |
| 45415K | Ø4.1 mm | 5.0 mm | 4.0 mm |
| 45404K | Ø4.1 mm | 6.0 mm | 0.5 mm |
| 45405K | Ø4.1 mm | 6.0 mm | 1.5 mm |
| 45406K | Ø4.1 mm | 6.0 mm | 2.5 mm |
| 45407K | Ø4.1 mm | 6.0 mm | 4.0 mm |

Quick-Abutment

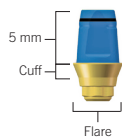

| <i>Catalog #</i> | <i>Description</i> | <i>Flare</i> | <i>Cuff Height</i> |
|------------------|--------------------|--------------|--------------------|
| 45435K | Ø4.1 mm | 5.0 mm | 0.5 mm |
| 45436K | Ø4.1 mm | 5.0 mm | 1.5 mm |
| 45437K | Ø4.1 mm | 5.0 mm | 2.5 mm |
| 45438K | Ø4.1 mm | 5.0 mm | 4.0 mm |
| 45424K | Ø4.1 mm | 6.0 mm | 0.5 mm |
| 45425K | Ø4.1 mm | 6.0 mm | 1.5 mm |
| 45426K | Ø4.1 mm | 6.0 mm | 2.5 mm |
| 45427K | Ø4.1 mm | 6.0 mm | 4.0 mm |

Quick-Abutment Quick-Cap®



| <i>Catalog #</i> | <i>Description</i> | <i>Flare</i> |
|------------------|--------------------|--------------|
| 45443K | Ø4.1 mm, 1-Pack | 5.0 mm |
| 45433K | Ø4.1 mm, 1-Pack | 6.0 mm |

**Quick-Abutment
Temporary/Healing Cap**



| <i>Catalog #</i> | <i>Description</i> | <i>Flare</i> |
|------------------|--------------------|--------------|
| 45236K | Ø4.1 mm | 5.0 mm |
| 45210K | Ø4.1 mm | 6.0 mm |

Quick-Abutment Analog



| <i>Catalog #</i> | <i>Description</i> | <i>Flare</i> |
|------------------|--------------------|--------------|
| 45448K | Ø4.1 mm | 5.0 mm |
| 45446K | Ø4.1 mm | 6.0 mm |

Quick-Abutment Plastic Sleeve



| <i>Catalog #</i> | <i>Description</i> | <i>Flare</i> |
|------------------|----------------------|--------------|
| 45240K | Ø4.1 mm, Locking | 5.0 mm |
| 45242K | Ø4.1 mm, Non-Locking | 5.0 mm |
| 45216K | Ø4.1 mm, Locking | 6.0 mm |
| 45219K | Ø4.1 mm, Non-Locking | 6.0 mm |

Quick-Abutment Ceramic Coping



| <i>Catalog #</i> | <i>Description</i> | <i>Flare</i> |
|------------------|--------------------|--------------|
| 45244K | Ø4.1 mm | 5.0 mm |
| 45302K | Ø4.1 mm | 6.0 mm |

Quick-Abutment Plastic Sleeve Reamer Tool



| <i>Catalog #</i> | <i>Description</i> |
|------------------|--------------------------------|
| 45311K | Reamer Tool and Centering Pins |

Prepable Abutment



| <i>Catalog #</i> | <i>Description</i> |
|------------------|--------------------|
| 45043K | Ø4.1 mm |

Multi Unit Abutment

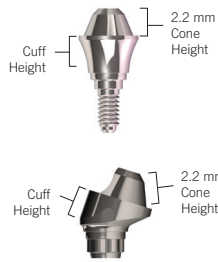

| <i>Catalog #</i> | <i>Description</i> | <i>Cuff Height</i> |
|------------------|----------------------|--------------------|
| 45315K | Ø4.1 mm, Straight | 1.0 mm |
| 45316K | Ø4.1 mm, Straight | 2.0 mm |
| 45317K | Ø4.1 mm, Straight | 3.0 mm |
| 45318K | Ø4.1 mm, Straight | 4.0 mm |
| 45323K | Ø4.1 mm, Angled, 17° | 3.0 mm |
| 45324K | Ø4.1 mm, Angled, 17° | 4.0 mm |
| 45965K | Ø4.1 mm, Angled, 30° | 3.0 mm |
| 45325K | Ø4.1 mm, Angled, 30° | 4.0 mm |
| 45326K | Ø4.1 mm, Angled, 30° | 5.0 mm |

**Multi Unit Abutment
Healing Cap**



Catalog # *Description*

45330K Ø4.1 mm

**Multi Unit Abutment
Impression Post**



Catalog # *Description*

45327K Open Tray, Ø4.1 mm with screw
45328K Closed Tray, Ø4.1 mm

**Multi Unit Abutment
Analog**



Catalog # *Description*

45329K Ø4.1 mm

**Multi-Unit Abutment
Ti Temporary Sleeve**



Catalog # *Description*

45331K Ø4.1 mm

**Multi Unit Abutment
Plastic Sleeve**



Catalog # *Description*

45332K Ø4.1 mm

**Multi Unit Abutment
Prosthetic Screw**



Catalog # *Description*

45333K 1-Pack

**Angled Multi-Unit Abutment
Replacement Screw**



Catalog # *Description*

45334K 1-Pack



Prima Plus™ Implants
Internal TiLobe®

Prima Plus™ Implants



Catalog #

- 15740K**
- 15741K**
- 15742K**
- 15743K**
- 15744K**

- 15745K**
- 15746K**
- 15747K**
- 15748K**

Implant Size

- Ø5.0 x 8 mm Length
- Ø5.0 x 10 mm Length
- Ø5.0 x 11.5 mm Length
- Ø5.0 x 13 mm Length
- Ø5.0 x 15 mm Length

- Ø6.0 x 8 mm Length
- Ø6.0 x 10 mm Length
- Ø6.0 x 11.5 mm Length
- Ø6.0 x 13 mm Length

Cover Screw



Catalog #

- 15312K**

Description

Ø5.0 mm

Healing Abutments



Catalog #

- 15313K**
- 15314K**

- 15321K**
- 15322K**

- 15315K**
- 15316K**

- 15789K**
- 15790K**

- 15791K**
- 15792K**

Description

- Ø5.0/6.0 mm
- Ø5.0/6.0 mm

- Ø5.0/6.0 mm
- Ø5.0/6.0 mm

- Ø5.0/6.0 mm
- Ø5.0/6.0 mm

- Ø5.0/6.0 mm
- Ø5.0/6.0 mm

- Ø5.0/6.0 mm
- Ø5.0/6.0 mm

Flare

- Straight
- Straight

- 5.0 mm
- 5.0 mm

- 6.0 mm
- 6.0 mm

- 7.0 mm
- 7.0 mm

- 8.0 mm
- 8.0 mm

Cuff Height

- 3.0 mm
- 5.0 mm

- 3.0 mm
- 5.0 mm

- 3.0 mm
- 5.0 mm

- 3.0 mm
- 5.0 mm

The Ø5.0 mm Prima Plus™ can be restored with straight, Ø5.0 and Ø6.0 mm flared prosthetic components. An Abutment Screw is included with all TiLobe® abutments.

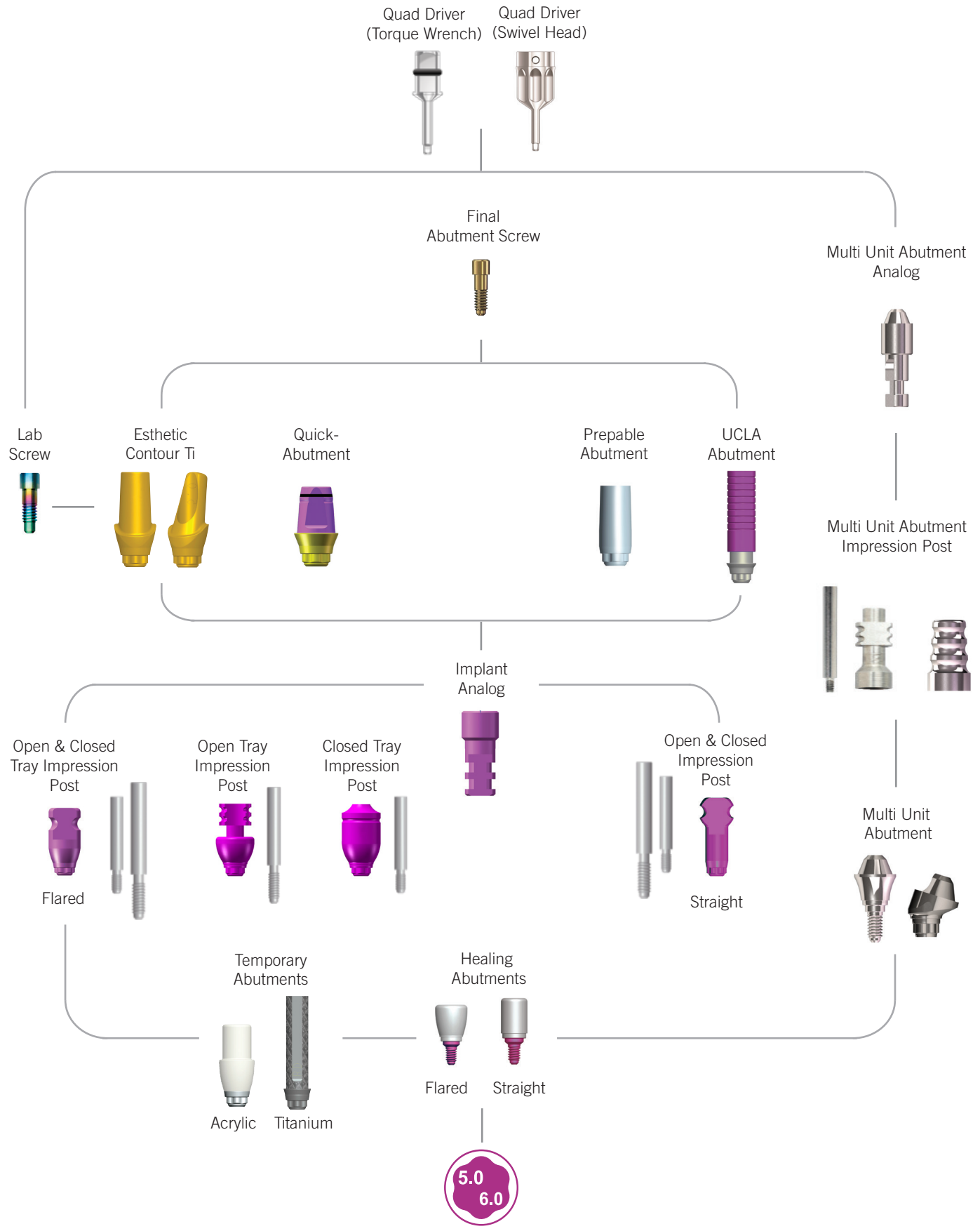



Prosthetic Components

Internal TiLobe®

Open & Closed Tray Impression Post



| Catalog # | Description | Flare |
|-----------|-------------|----------|
| 45134K | Ø5.0/6.0 mm | Straight |
| 45138K | Ø5.0/6.0 mm | 5.0 mm |
| 45135K | Ø5.0/6.0 mm | 6.0 mm |

Open Tray Impression Post



| Catalog # | Description | Flare |
|-----------|-------------|--------|
| 45916K | Ø5.0/6.0 mm | 7.0 mm |
| 45918K | Ø5.0/6.0 mm | 8.0 mm |

Closed Tray Impression Post



| Catalog # | Description | Flare |
|-----------|-------------|--------|
| 45917K | Ø5.0/6.0 mm | 7.0 mm |
| 45919K | Ø5.0/6.0 mm | 8.0 mm |

Implant Analog



| Catalog # | Description |
|-----------|----------------------|
| 45142K | Ø5.0/6.0 mm, 1-Pack |
| 45145K | Ø5.0/6.0 mm, 10-Pack |
| 45956K | Ø6.0 mm, 1-Pack |

Temporary Abutment



| Catalog # | Description | Flare |
|-----------|----------------------|--------|
| 45122K | Ø5.0 mm, Locking | 5.0 mm |
| 45123K | Ø5.0 mm, Non-Locking | 5.0 mm |
| 45116K | Ø5.0/6.0 mm, Locking | 6.0 mm |

Ti Temporary Abutment



| Catalog # | Description |
|-----------|--------------------------|
| 45079K | Ø5.0/6.0 mm, Locking |
| 45080K | Ø5.0/6.0 mm, Non-Locking |

Esthetic Contour Ti Abutment

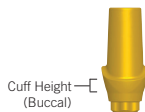

| Catalog # | Description | Flare | Cuff Height |
|-----------|-------------------------|--------|-------------|
| 45054K | Ø5.0/6.0 mm, Straight | 5.0 mm | 0.5 mm |
| 45055K | Ø5.0/6.0 mm, Straight | 5.0 mm | 1.5 mm |
| 45056K | Ø5.0/6.0 mm, 15° Angled | 5.0 mm | 0.5 mm |
| 45057K | Ø5.0/6.0 mm, 15° Angled | 5.0 mm | 1.5 mm |
| 45038K | Ø5.0/6.0 mm, Straight | 6.0 mm | 1.0 mm |
| 45039K | Ø5.0/6.0 mm, Straight | 6.0 mm | 3.0 mm |
| 45040K | Ø5.0/6.0 mm, 15° Angled | 6.0 mm | 1.0 mm |

UCLA Abutment



| Catalog # | Description | Cuff Height |
|-----------|----------------------------------|-------------|
| 45104K | Gold/Plastic Sleeve, Locking | 1.0 mm |
| 45105K | Gold/Plastic Sleeve, Non-Locking | 1.0 mm |

**Replacement
Final Abutment Screw**



Catalog # Description

45060K 1-Pack

Laboratory Screw



Catalog # Description

45061K 10-Pack

Quick-Packs



Catalog # Description Flare Cuff Height

| | | | |
|---------------|-------------|--------|--------|
| 45416K | Ø5.0/6.0 mm | 5.0 mm | 0.5 mm |
| 45417K | Ø5.0/6.0 mm | 5.0 mm | 1.5 mm |
| 45418K | Ø5.0/6.0 mm | 5.0 mm | 2.5 mm |
| 45419K | Ø5.0/6.0 mm | 5.0 mm | 4.0 mm |
| 45408K | Ø5.0/6.0 mm | 6.0 mm | 0.5 mm |
| 45409K | Ø5.0/6.0 mm | 6.0 mm | 1.5 mm |
| 45410K | Ø5.0/6.0 mm | 6.0 mm | 2.5 mm |
| 45411K | Ø5.0/6.0 mm | 6.0 mm | 4.0 mm |

Quick-Abutment

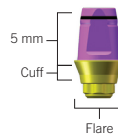

Catalog # Description Flare Cuff Height

| | | | |
|---------------|-------------|--------|--------|
| 45439K | Ø5.0/6.0 mm | 5.0 mm | 0.5 mm |
| 45440K | Ø5.0/6.0 mm | 5.0 mm | 1.5 mm |
| 45441K | Ø5.0/6.0 mm | 5.0 mm | 2.5 mm |
| 45442K | Ø5.0/6.0 mm | 5.0 mm | 4.0 mm |
| 45428K | Ø5.0/6.0 mm | 6.0 mm | 0.5 mm |
| 45429K | Ø5.0/6.0 mm | 6.0 mm | 1.5 mm |
| 45430K | Ø5.0/6.0 mm | 6.0 mm | 2.5 mm |
| 45431K | Ø5.0/6.0 mm | 6.0 mm | 4.0 mm |

Quick-Abutment Quick-Cap®



Catalog # Description Flare

| | | |
|---------------|---------------------|--------|
| 45444K | Ø5.0/6.0 mm, 1-Pack | 5.0 mm |
| 45434K | Ø5.0/6.0 mm, 1-Pack | 6.0 mm |

**Quick-Abutment
Temporary/Healing Cap**



Catalog # Description Flare

| | | |
|---------------|-------------|--------|
| 45237K | Ø5.0/6.0 mm | 5.0 mm |
| 45211K | Ø5.0/6.0 mm | 6.0 mm |

Quick-Abutment Analog



Catalog # Description Flare

| | | |
|---------------|-------------|--------|
| 45449K | Ø5.0/6.0 mm | 5.0 mm |
| 45447K | Ø5.0/6.0 mm | 6.0 mm |



Quick-Abutment Plastic Sleeve



| Catalog # | Description | Flare |
|---------------|--------------------------|--------|
| 45241K | Ø5.0/6.0 mm, Locking | 5.0 mm |
| 45243K | Ø5.0/6.0 mm, Non-Locking | 5.0 mm |
| 45217K | Ø5.0/6.0 mm, Locking | 6.0 mm |
| 45220K | Ø5.0/6.0 mm, Non-Locking | 6.0 mm |

Quick-Abutment Ceramic Coping



| Catalog # | Description | Flare |
|---------------|-------------|--------|
| 45245K | Ø5.0/6.0 mm | 5.0 mm |
| 45303K | Ø5.0/6.0 mm | 6.0 mm |

Quick-Abutment Plastic Sleeve Reamer Tool



| Catalog # | Description |
|---------------|--------------------------------|
| 45311K | Reamer Tool and Centering Pins |

Prepable Abutment



| Catalog # | Description |
|---------------|-------------|
| 45044K | Ø5.0/6.0 mm |

Multi Unit Abutment

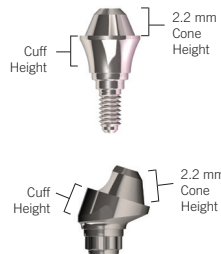

| Catalog # | Description | Cuff Height |
|---------------|----------------------------------|-------------|
| 45319K | Ø5.0/6.0 mm, Straight | 1.0 mm |
| 45320K | Ø5.0/6.0 mm, Straight | 2.0 mm |
| 45939K | Ø5.0/5.5/6.0/6.5 mm, Straight | 3.0 mm |
| 45940K | Ø5.0/5.5/6.0/6.5 mm, Straight | 4.0 mm |
| 45941K | Ø5.0/5.5/6.0/6.5 mm, Angled, 17° | 3.0 mm |
| 45942K | Ø5.0/5.5/6.0/6.5 mm, Angled, 17° | 4.0 mm |
| 45966K | Ø5.0/6.0 mm, Angled, 30° | 3.0 mm |
| 45967K | Ø5.0/6.0 mm, Angled, 30° | 4.0 mm |

**Multi Unit Abutment
Healing Cap**



| <i>Catalog #</i> | <i>Description</i> |
|------------------|--------------------|
| 45330K | Ø5.0/6.0 mm |

**Multi Unit Abutment
Impression Post**



| <i>Catalog #</i> | <i>Description</i> |
|------------------|-----------------------------------|
| 45327K | Open Tray, Ø5.0/6.0 mm with screw |
| 45328K | Closed Tray, Ø5.0/6.0 mm |

**Multi Unit Abutment
Analog**



| <i>Catalog #</i> | <i>Description</i> |
|------------------|--------------------|
| 45329K | Ø5.0/6.0 mm |

**Multi-Unit Abutment
Ti Temporary Sleeve**



| <i>Catalog #</i> | <i>Description</i> |
|------------------|--------------------|
| 45331K | Ø5.0/6.0 mm |

**Multi Unit Abutment
Plastic Sleeve**



| <i>Catalog #</i> | <i>Description</i> |
|------------------|--------------------|
| 45332K | Ø5.0/6.0 mm |

**Multi Unit Abutment
Prosthetic Screw**



| <i>Catalog #</i> | <i>Description</i> |
|------------------|--------------------|
| 45333K | 1-Pack |

**Angled Multi-Unit Abutment
Replacement Screw**



| <i>Catalog #</i> | <i>Description</i> |
|------------------|--------------------|
| 45334K | 1-Pack |

Digital

Angled Abutment Drivers
(Latch Type) (Torque Wrench)

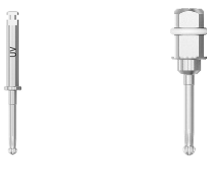

Angulated Screw



Ti-Base



Angulated Screw Channel

Quad Driver (Torque Wrench) Quad Driver (Swivel Head)

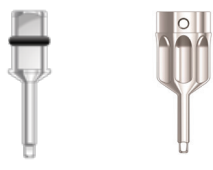

Final Abutment Screw



Ti-Base



Locking



Non-Locking

Ti-Blanks



Digital Scanbodies



Digital Analog



Download Digital Libraries from Imagine



Temporary Abutments



Acrylic



Titanium





Healing Abutment





Ø4.1 Shown



| Digital Scanbodies | Catalog # | Description |
|-----------------------------------------------------------------------------------|-------------------|----------------------|
|  | IM-SBKEP35 | Mist IC Scanbody 3.5 |
| | IM-SBKEP41 | Mist IC Scanbody 4.1 |
| | IM-SBKEP50 | Mist IC Scanbody 5.0 |

| Digital Analog | Catalog # | Description |
|-----------------------------------------------------------------------------------|-------------------|-----------------------|
|  | IM-3DKEP35 | Mist IC 3D Analog 3.5 |
| | IM-3DKEP41 | Mist IC 3D Analog 4.1 |
| | IM-3DKEP50 | Mist IC 3D Analog 5.0 |

| Tibase (Locking) | Catalog # | Description |
|-------------------------------------------------------------------------------------|-------------------|---------------------------|
|  | IM-LLKEP35 | Mist IC L-Link Single 3.5 |
| | IM-LLKEP41 | Mist IC L-Link Single 4.1 |
| | IM-LLKEP50 | Mist IC L-Link Single 5.0 |

| Tibase (Non-Locking) | Catalog # | Description |
|-------------------------------------------------------------------------------------|-------------------|-----------------------|
|  | IM-3DKEP35 | Mist IC 3D Analog 3.5 |
| | IM-3DKEP41 | Mist IC 3D Analog 4.1 |
| | IM-3DKEP50 | Mist IC 3D Analog 5.0 |

| Tibase Angulated Screw Channel | Catalog # | Description |
|-------------------------------------------------------------------------------------|-------------------|--------------------|
|  | IM-SLKEP35 | Mist IC S-Link 3.5 |
| | IM-SLKEP41 | Mist IC S-Link 4.1 |
| | IM-SLKEP50 | Mist IC S-Link 5.0 |

Imagine MIST abutments are packaged with a final screw (gold hue) and a lab screw (gray hue).

Ti Blanks 10



| <i>Catalog #</i> | <i>Description</i> |
|---------------------|-----------------------|
| IM-PF10KEP35 | Mist IC PreFit10, 3.5 |
| IM-PF10KEP41 | Mist IC PreFit10, 4.1 |
| IM-PF10KEP50 | Mist IC PreFit10, 5.0 |

Ti Blanks 14



| <i>Catalog #</i> | <i>Description</i> |
|---------------------|-----------------------|
| IM-PF14KEP35 | Mist IC PreFit14, 3.5 |
| IM-PF14KEP41 | Mist IC PreFit14, 4.1 |
| IM-PF14KEP50 | Mist IC PreFit14, 5.0 |

Final Abutment Screws

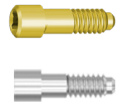

| <i>Catalog #</i> | <i>Description</i> |
|--------------------|-------------------------------------|
| IM-SCKEP | Mist IC Screw (Pack of 5) |
| IM-SCKEP UV | Mist IC Angulated Screw (Pack of 5) |

Angled Abutment Drivers

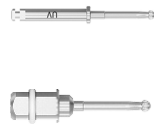

| <i>Catalog #</i> | <i>Description</i> |
|------------------|------------------------------------------|
| IM-ALDUVR | Mist IC Angled Latch Driver Reg (13mm) |
| IM-ALDUVL | Mist IC Angled Latch Driver Long (20mm) |
| IM-ASDUVR | Mist IC Angled Square Driver Reg (13mm) |
| IM-ASDUVL | Mist IC Angled Square Driver Long (20mm) |

Quad Drivers



| <i>Catalog #</i> | <i>Description</i> |
|------------------|-----------------------------|
| 15272K | Swivel Head, Short |
| 15273K | Swivel Head, Long |
| 45293K | Swivel Head, X-Long (35 mm) |
| 15274K | Latch Type, Short |
| 15275K | Latch Type, Long |
| 45294K | Latch Type, X-Long (35 mm) |
| 15276K | Torque Wrench, Short |
| 15277K | Torque Wrench, Long |

Quad Driver (Torque Wrench) Quad Driver (Swivel Head)

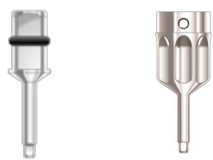

Final Abutment Screw

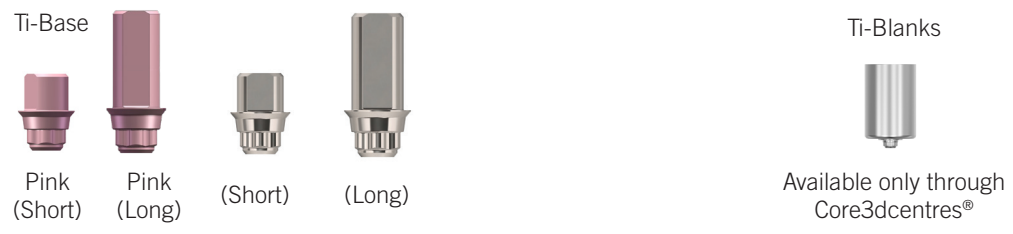

Scan Abutment Digital Analog



Download Digital Libraries from Core3dcentres®



Temporary Abutments

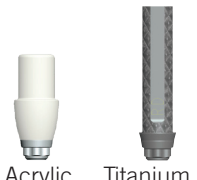

Healing Abutment



Ø4.1 Shown



Scan Abutment



Catalog #

Description

- CORE3D-4812** Scan Abutment Prima Plus™ ø3.5
- CORE3D-4813** Scan Abutment Prima Plus™ ø4.1
- CORE3D-4814** Scan Abutment Prima Plus™ ø5.0
- CORE3D-4815** Scan Abutment Prima Plus™ ø6.0

Digital Analog



Catalog #

Description

- CORE3D-4798** Digital Analog Prima Plus™ ø3.5
- CORE3D-4799** Digital Analog Prima Plus™ ø4.1
- CORE3D-4800** Digital Analog Prima Plus™ ø5.0
- CORE3D-4749** Digital Analog Prima Plus™ ø6.0

Ti Base (Short)



Catalog #

Description

- 45806K** Ti Base Insert ø3.5/3.8, Short
- 45807K** Ti Base Insert ø4.1/4.5, Short
- 45808K** Ti Base Insert ø5.0/5.5/6.5, Short

Ti Base (Long)



Catalog #

Description

- 45901K** Ti Base Insert ø3.5, Long
- 45902K** Ti Base Insert ø4.1, Long
- 45903K** Ti Base Insert ø5.0, Long

Ti Base Pink (Short)



Catalog #

Description

- 45809K** Ti Base Insert ø3.5/3.8, Short
- 45810K** Ti Base Insert ø4.1/4.5, Short
- 45811K** Ti Base Insert ø5.0/5.5/6.5, Short

Ti Base Pink (Long)



Catalog #

Description

- 45812K** Ti Base Insert ø3.5/3.8, Long
- 45813K** Ti Base Insert ø4.1/4.5, Long
- 45814K** Ti Base Insert ø5.0/5.5/6.5, Long

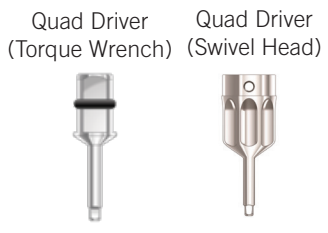

Final Abutment Screw



Esthetic Contour Ti-Base Abutment



Esthetic Contour Ti Digital Impression Post



Healing Abutment



Ø4.1 Shown

Esthetic Contour Ti Digital Impression Post



Catalog #

- 45933K
- 45934K
- 45935K

Description

- Esthetic Contour Ti Digital Impression Post ø3.5
- Esthetic Contour Ti Digital Impression Post ø4.1
- Esthetic Contour Ti Digital Impression Post ø5.0

Esthetic Contour Ti-Base Abutment



Catalog #

- 45930K
- 45931K
- 45932K

Description

- Esthetic Contour Ti-Base Abutment ø3.5
- Esthetic Contour Ti-Base Abutment ø4.1
- Esthetic Contour Ti-Base Abutment ø5.0

LOCATOR[®] Abutments



LOCATOR® Abutments

Prosthetic Options

LOCATOR®
Core Tool



Retention
Insert Tool



LOCATOR®
Analog



Abutment
Analog



Impression
Coping



Impression
Coping



LOCATOR®
Abutment



LOCATOR
R-Tx™
Abutment

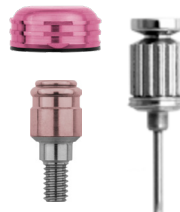

LOCATOR® Abutment Assembly



| <i>Catalog #</i> | <i>Description</i> | <i>Cuff Height</i> |
|------------------|--------------------|--------------------|
| 45062K | Ø3.5 mm | 1.0 mm |
| 45258K | Ø3.5 mm | 2.0 mm |
| 45259K | Ø3.5 mm | 3.0 mm |
| 45260K | Ø3.5 mm | 4.0 mm |
| 45063K | Ø3.5 mm | 5.0 mm |
| 45064K | Ø3.5 mm | 6.0 mm |
| 45065K | Ø4.1 mm | 1.0 mm |
| 45261K | Ø4.1 mm | 2.0 mm |
| 45262K | Ø4.1 mm | 3.0 mm |
| 45263K | Ø4.1 mm | 4.0 mm |
| 45066K | Ø4.1 mm | 5.0 mm |
| 45067K | Ø4.1 mm | 6.0 mm |
| 45068K | Ø5.0/6.0 mm | 1.0 mm |
| 45264K | Ø5.0/6.0 mm | 2.0 mm |
| 45265K | Ø5.0/6.0 mm | 3.0 mm |
| 45069K | Ø5.0/6.0 mm | 4.0 mm |
| 45070K | Ø5.0/6.0 mm | 5.0 mm |
| 45071K | Ø5.0/6.0 mm | 6.0 mm |

LOCATOR® Abutment Accessories



| <i>Catalog #</i> | <i>Description</i> |
|------------------|--------------------------------------------------------------------------------------------------|
| L8519-2 | Denture Cap with Black Processing Male, 2-Pack Clear, Pink, Blue Retention, Block out spacers |
| 45266K | LOCATOR® Replacement Male, Clear, Standard Retention, 4-Pack |
| 45267K | LOCATOR® Replacement Male, Pink, Light Retention, 4-Pack |
| 45268K | LOCATOR® Replacement Male, Blue, (ELR) Extra Light Retention, 4-Pack |
| 45269K | LOCATOR® Replacement Male, Green, (ER) Extended Range, 4-Pack |
| 45270K | LOCATOR® Female Analog, 4-Pack |
| 45271K | LOCATOR® Impression Coping, 4-Pack |
| 45273K | LOCATOR® Core Tool |
| 45274K | LOCATOR® Torque Wrench Driver |



LOCATOR® R-Tx™ Abutment
Internal TiLobe®

**LOCATOR R-Tx™
Abutment**



| <i>Catalog #</i> | <i>Description</i> | <i>Cuff Height</i> |
|-------------------------|--------------------|--------------------|
| LOCR-TX 31200-01 | Ø3.5 mm | 1.0 mm |
| LOCR-TX 31200-02 | Ø3.5 mm | 2.0 mm |
| LOCR-TX 31200-03 | Ø3.5 mm | 3.0 mm |
| LOCR-TX 31200-04 | Ø3.5 mm | 4.0 mm |
| LOCR-TX 31200-05 | Ø3.5 mm | 5.0 mm |
| LOCR-TX 31200-06 | Ø3.5 mm | 6.0 mm |
| LOCR-TX 31201-01 | Ø4.1 mm | 1.0 mm |
| LOCR-TX 31201-02 | Ø4.1 mm | 2.0 mm |
| LOCR-TX 31201-03 | Ø4.1 mm | 3.0 mm |
| LOCR-TX 31201-04 | Ø4.1 mm | 4.0 mm |
| LOCR-TX 31201-05 | Ø4.1 mm | 5.0 mm |
| LOCR-TX 31201-06 | Ø4.1 mm | 6.0 mm |
| LOCR-TX 31202-01 | Ø5.0/6.0 mm | 1.0 mm |
| LOCR-TX 31202-02 | Ø5.0/6.0 mm | 2.0 mm |
| LOCR-TX 31202-03 | Ø5.0/6.0 mm | 3.0 mm |
| LOCR-TX 31202-04 | Ø5.0/6.0 mm | 4.0 mm |
| LOCR-TX 31202-05 | Ø5.0/6.0 mm | 5.0 mm |
| LOCR-TX 31202-06 | Ø5.0/6.0 mm | 6.0 mm |

**LOCATOR R-Tx™
Abutment Accessories**



| <i>Catalog #</i> | <i>Description</i> |
|-------------------------|------------------------------------------------|
| LOCR-TX 30013-01 | Denture Attachment Processing Assembly, 4-Pack |
| LOCR-TX 30001-01 | Zero Retention Insert, 4-Pack |
| LOCR-TX 30002-01 | Low Retention Insert, 4-Pack |
| LOCR-TX 30003-01 | Medium Retention Insert, 4-Pack |
| LOCR-TX 30004-01 | High Retention Insert, 4-Pack |
| LOCR-TX 30014-01 | 3.35 mm Abutment Analog, 4-Pack |
| LOCR-TX 30015-01 | 4.0 mm Abutment Analog, 4-Pack |
| LOCR-TX 30016-01 | 5.0 mm Abutment Analog, 4-Pack |
| LOCR-TX 30017-01 | Impression Coping, 4-Pack |
| LOCR-TX 30021-01 | Retention Insert Tool |
| LOCR-TX 04936 | .050"/1.25 mm Hex, Torque Wrench |
| LOCR-TX 08007 | .050"/1.25 mm Hex Driver with Thumb Knob |
| LOCR-TX 08008 | .050"/1.25 mm Hex, Latch Lock Driver |
| LOCR-TX 30012-01 | Processing Insert, 4-Pack |
| LOCR-TX 30018-01 | Processing Spacer, 4-Pack |

**LOCATOR F-Tx®
Abutment**



| <i>Catalog #</i> | <i>Description</i> | <i>Cuff Height</i> |
|-------------------------|--------------------|--------------------|
| LOCF-TX 11200-01 | Ø3.5 mm | 1.0 mm |
| LOCF-TX 11200-02 | Ø3.5 mm | 2.0 mm |
| LOCF-TX 11200-03 | Ø3.5 mm | 3.0 mm |
| LOCF-TX 11200-04 | Ø3.5 mm | 4.0 mm |
| LOCF-TX 11200-05 | Ø3.5 mm | 5.0 mm |
| LOCF-TX 11201-01 | Ø4.1 mm | 1.0 mm |
| LOCF-TX 11201-02 | Ø4.1 mm | 2.0 mm |
| LOCF-TX 11201-03 | Ø4.1 mm | 3.0 mm |
| LOCF-TX 11201-04 | Ø4.1 mm | 4.0 mm |
| LOCF-TX 11201-05 | Ø4.1 mm | 5.0 mm |
| LOCF-TX 11202-01 | Ø5.0/6.0 mm | 1.0 mm |
| LOCF-TX 11202-02 | Ø5.0/6.0 mm | 2.0 mm |
| LOCF-TX 11202-03 | Ø5.0/6.0 mm | 3.0 mm |
| LOCF-TX 11202-04 | Ø5.0/6.0 mm | 4.0 mm |
| LOCF-TX 11202-05 | Ø5.0/6.0 mm | 5.0 mm |

**LOCATOR F-Tx™
Abutment Accessories**



| <i>Catalog #</i> | <i>Description</i> |
|-------------------------|-----------------------------------|
| LOCF-TX 10028-01 | Manual Driver |
| LOCF-TX 10029-01 | Latch Driver |
| LOCF-TX 10030-01 | Processing Cap, 2Pk |
| LOCF-TX 10032-01 | Processing Ball, 2Pk |
| LOCF-TX 10033-01 | Low Retention Ball, 2Pk |
| LOCF-TX 10034-01 | Medium Retention Ball, 2Pk |
| LOCF-TX 10035-01 | High Retention Ball, 2 Pk |
| LOCF-TX 10036-01 | Healing Cap, 2Pk |
| LOCF-TX 10037-01 | Abutment Analog, 2Pk |
| LOCF-TX 10039-01 | Polishing Cap, 2Pk |
| LOCF-TX 10040-01 | Waxing Cap, 2Pk |
| LOCF-TX 10041-01 | Denture Attachment Housing, 2Pk |
| LOCF-TX 10042-01 | Retention Ball Hex Driver |
| LOCF-TX 10043-01 | Impression Coping, 2Pk |
| LOCF-TX 10094 | Tip Wrench |
| LOCF-TX 10095 | Seating Tip |
| LOCF-TX 10096 | Removal Tip with Threaded Adapter |
| LOCF-TX 10097 | Replacement Wire |
| LOCF-TX 10098 | Threaded Adapter |
| LOCF-TX 10099 | Wire and Lever Wrench |
| LOCF-TX 100100 | Seating and Removal Tool |

Surgical Kit & Instruments

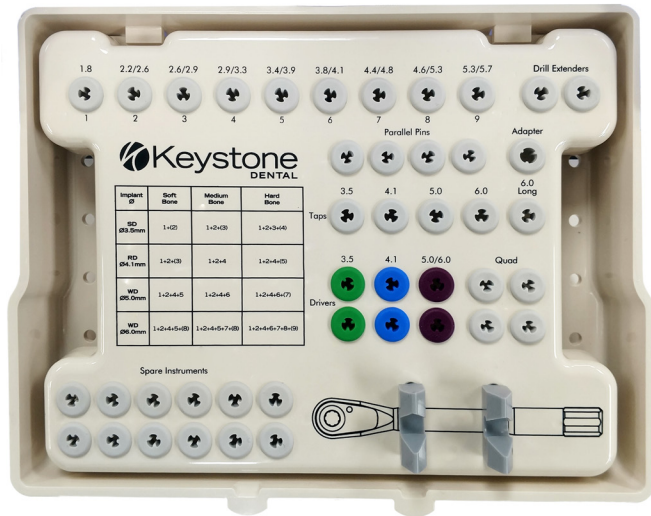

Catalog # Surgical Options

| | |
|---------------|---------------------------|
| 15729K | Surgical Cassette (empty) |
| 15728K | Prima Plus™ Surgical Kit |

Catalog # Description

| | |
|------------------|----------------------------------------------|
| 15728K | Prima Plus™ Surgical Kit <i>Includes:</i> |
| 15729K | Surgical Cassette |
| 15750K | 1.8 x 15 mm Initial Drill |
| 15752K | 2.2/2.6 Twist Step Drill, 8-15 mm |
| 15754K | 2.6/2.9 Twist Step Drill, 8-15 mm |
| 15756K | 2.9/3.3 Twist Step Drill, 8-15 mm |
| 15758K | 3.4/3.9 Twist Step Drill, 8-15 mm |
| 15760K | 3.8/4.1 Twist Step Drill, 8-15 mm |
| 15762K | 4.4/4.8 Twist Step Drill, 8-15 mm |
| 15764K | 4.6/5.3 Twist Step Drill, 8-15 mm |
| 15766K | 5.3/5.7 Twist Step Drill, 8-15 mm |
| 15770K | 3.5 Implant Driver, Short |
| 15771K | 3.5 Implant Driver, Long |
| 15772K | 4.1 Implant Driver, Short |
| 15773K | 4.1 Implant Driver, Long |
| 15774K | 5.0/6.0 Implant Driver, Short |
| 15775K | 5.0/6.0 Implant Driver, Long |
| L1404-01K | Drill Extender |

Catalog # Description

| | |
|--------------------|--------------------------------|
| 15776K | Parallel Pin, 1.8 x 8-15 mm |
| 15274K | Quad Driver, Latch, Short |
| 15275K | Quad Driver, Latch, Long |
| 15272K | Quad Driver, Swivel, Short |
| 15273K | Quad Driver, Swivel, Long |
| 15224K | Ratchet Adapter |
| K15695 | Surgical Ratchet/Torque Wrench |
| 100045-EN01 | Prima Plus™ Surgical Manual |
| 100046-EN01 | Wall Chart |
| 100047-EN01 | Drill Usage Chart |



Tissue Punch

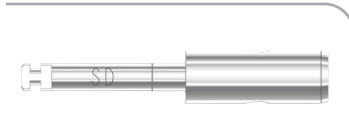

Catalog #

Description

15237K
15238K
15239K

Ø3.5 mm, with Guide Pin
Ø4.1 mm, with Guide Pin
Ø5.0/6.0 mm, with Guide Pin

Initial Drills

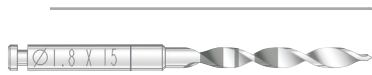

Catalog #

Description

15750K
15751K

Ø1.8 x 8-15 mm
Ø1.8 x 8-11.5 mm

Parallel Pin

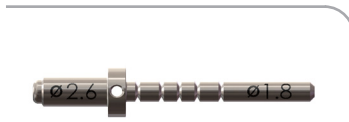

Catalog #

Description

15776K

1.8 x 8-15 mm

Twist Step Drills



Catalog #

Description

15752K
15753K

2.2/2.6 Twist Step Drill, 8-15 mm
2.2/2.6 Twist Step Drill, 8-11.5 mm

15754K
15755K

2.6/2.9 Twist Step Drill, 8-15 mm
2.6/2.9 Twist Step Drill, 8-11.5 mm

15756K
15757K

2.9/3.3 Twist Step Drill, 8-15 mm
2.9/3.3 Twist Step Drill, 8-11.5 mm

15758K
15759K

3.4/3.9 Twist Step Drill, 8-15 mm
3.4/3.9 Twist Step Drill, 8-11.5 mm

15760K
15761K

3.8/4.1 Twist Step Drill, 8-15 mm
3.8/4.1 Twist Step Drill, 8-11.5 mm

15762K
15763K

4.4/4.8 Twist Step Drill, 8-15 mm
4.4/4.8 Twist Step Drill, 8-11.5 mm

15764K
15765K

4.6/5.3 Twist Step Drill, 8-15 mm
4.6/5.3 Twist Step Drill, 8-11.5 mm

15766K
15767K

5.3/5.7 Twist Step Drill, 8-13 mm
5.3/5.7 Twist Step Drill, 8-11.5 mm



Surgical Taps



| Catalog # | Description |
|-----------|------------------|
| 15784K | Ø3.5 x 8-15 mm |
| 15785K | Ø4.1 x 8-15 mm |
| 15786K | Ø5.0 x 8-15 mm |
| 15787K | Ø6.0 x 8-11.5 mm |
| 15788K | Ø6.0 x 13 mm |

Bone Profiler

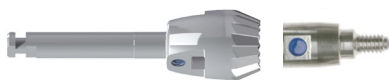

| Catalog # | Description |
|-----------|-------------------------|
| 15279K | Ø3.5 mm, with Guide Pin |
| 15280K | Ø4.1 mm, with Guide Pin |
| 15281K | Ø5.0 mm, with Guide Pin |
| 15778K | Ø6.0 mm, with Guide Pin |

**Prima Plus™
Implant Driver, Ratchet**



| Catalog # | Description |
|-----------|-------------|
| 15282K | Ø3.5 mm |
| 15283K | Ø4.1 mm |
| 15284K | Ø5.0/6.0 mm |

**Prima Plus™
Implant Driver, Latch**

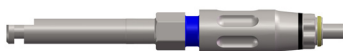

| Catalog # | Description |
|-----------|-----------------------------------|
| 15770K | Ø3.5 mm Implant Driver, Short |
| 15771K | Ø3.5 mm Implant Driver, Long |
| 15772K | Ø4.1 mm Implant Driver, Short |
| 15773K | Ø4.1 mm Implant Driver, Long |
| 15774K | Ø5.0/6.0 mm Implant Driver, Short |
| 15775K | Ø5.0/6.0 mm Implant Driver, Long |

**Surgical Ratchet/
Torque Wrench**



| Catalog # | Description |
|-----------|--------------------------------|
| K15695 | Surgical Ratchet/Torque Wrench |

Quad Drivers



| Catalog # | Description |
|-----------|-----------------------------|
| 15272K | Swivel Head, Short |
| 15273K | Swivel Head, Long |
| 45293K | Swivel Head, X-Long (35 mm) |
| 15274K | Latch Type, Short |
| 15275K | Latch Type, Long |
| 45294K | Latch Type, X-Long (35 mm) |
| 15276K | Torque Wrench, Short |
| 15277K | Torque Wrench, Long |



Ratchet Adapter

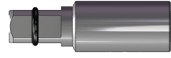

Catalog #

15224K

Conversion Handles

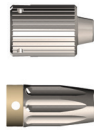

Catalog #

**L1407K
ISS1112K**

Description

Conversion Handle, Latch Type
Conversion Handle, Square

**Quick-Abutment Plastic Sleeve
Reamer Tool**



Catalog #

45311K

Description

Reamer Tool and Centering Pins

Surgical Hand Driver

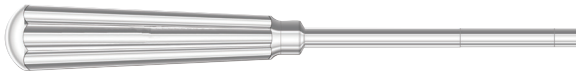

Catalog #

15271K

Osteotomes

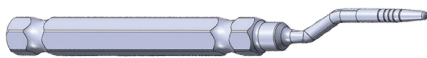

Catalog #

**15063K
15067K
15068K
15069K
15070K**

Description

Osteotome Kit, Round, with Tray
1.8-2.5 mm, Round, Condensing
1.9-3.0 mm, Round, Condensing
2.2-3.6 mm, Round, Condensing
2.8-4.5 mm, Round, Condensing

**15064K
15071K
15072K
15073K
15074K**

Osteotome Kit, Sinus, with Tray
1.8-2.5 mm, Concave, Sinus
1.9-3.0 mm, Concave, Sinus
2.2-3.6 mm, Concave, Sinus
2.8-4.5 mm, Concave, Sinus

15066K

Osteotome Tray (empty)

Surgical Motors & Accessories



Implantmed Surgical Motors



Catalog #

Description

- WH-90000207** SI-1015 Implantmed Base Motor Unit
- WH-90000213** SI-1015 Implantmed Motor Unit Fully Loaded
- WH-90000208** SI-1015 Implantmed Base Unit with Osstell
- WH-90000209** SI-1015 Implantmed Motor Unit, WiFi Footpedal Upgrade
- WH-90000210** SI-1015 Implantmed Motor Unit, WiFi Footpedal Upgrade & Osstell
- WH-90000211** SI-1015 Implantmed Motor Unit, LED+ Motor Upgrade & Osstell
- WH-90000212** SI-1015 Implantmed Motor Unit, LED + Motor Upgrade
- WH-90000214** SI-1015 Implantmed Motor Unit Fully Loaded & Osstell

Implantmed Classic Motor



Catalog #

Description

- WH-90000270** Implanted Classic + WI-75 E/EM Handpiece non LED
- WH-90000271** Implanted Classic + W5-75 LG Handpiece LED



Piezomed Surgical Unit & Accessories



| <i>Catalog #</i> | <i>Description</i> |
|--------------------|--------------------------|
| WH-06985000 | Piezomed handpiece 1.8m |
| WH-07004400 | Foot Pedal Piezomed |
| WH-07159200 | Piezomed handpiece 3.5m |
| WH-30078000 | Piezomed SA-320 1.8m |
| WH-30078001 | Piezomed SA-320 3.5m |
| WH-07173200 | Instrument Set Special |
| WH-07997090 | Instrument Kit Crestal A |
| WH-07173500 | Instrument Kit EX |
| WH-07022500 | B6 Tip |
| WH-07022600 | B7 Tip |

Implantmed Surgical Handpieces



| <i>Catalog #</i> | <i>Description</i> |
|--------------------|-------------------------------------------------------------------------------------------------------|
| WH-30058000 | S-11 1:1 Straight (For Implantmed SI-1015 LC motor only) |
| WH-30033000 | WS-75 L 20:1, Contra-angle (For Implantmed SI-1015 LC motor only) |
| WH-30065000 | WS-75 Contra-Angle 20:1 Dismantlable Handpiece for implant surgery (10-2,000 rpm) |
| WH-30032000 | WS-75 L G Contra-Angle 20:1 Dismantlable Handpiece with Mini LED + for implant surgery (10-2,000 rpm) |
| WH-90000210 | SI-1015 Implantmed Motor Unit, WiFi Footpedal Upgrade |
| WH-90000211 | SI-1015 Implantmed Motor Unit, LED+ Motor Upgrade |



Implantmed Surgical Motor & Accessories



May not be available in all markets.

| <i>Catalog #</i> | <i>Description</i> |
|--------------------|---------------------------------------------------------------------------------------------------------------------|
| WH-04363600 | Irrigation Tubing and Spike Assembly, 6-Pack, Disposable (for use with Implantmed series & Elcomed SA-310 motors) |
| WH-00929300 | Irrigation Tubing with Luer Lock, Green (10-Pack) |
| WH-04019000 | Irrigation Tubing Clips, 5-Pack (for use with Implantmed SI-310 motors to hold tubing to motor cable) |
| WH-02610500 | Irrigation Needle/Canula (for use with internally irrigated drills) |
| WH-06016400 | Y-Connector Complete |
| WH-06946300 | Irrigation Spray Clip (new series), Right Side, E/KM, Green (3-Pack) |
| WH-06946400 | Irrigation Spray Clip (new series), Light Side, Green (3-Pack) |
| WH-06946500 | Irrigation Spray Clip (new series), Right Side, Green (3-Pack) |
| WH-04757100 | Irrigation Spray Clip (new series), Left Side, E/KM, Black (3-Pack) |
| WH-05051000 | Irrigation Spray Clip (old series), Black (3-Pack) |
| WH-02139800 | Bur testing Gauge (to check all 2.35 mm & 1.6 mm burs) |
| WH-10940011 | W&H F-1 Service Oil, 400ml (Special shipping & handling [aerosol can] Contact Customer Service for shipping rates.) |
| WH-02038200 | Spray Cap for Service Oil (resuable replacement) |
| WH-04013500 | Sterilization Case |
| WH-30264001 | S-NW + SPI WiFi Foot Pedal (for Elcomed SA-310 & Implantmed SI-915 white only) |
| WH-30264000 | S-NW + CAN WiFi Foot Pedal (For Implantmed SI-1015 only) |
| WH-30210000 | Osstell ISQ Module (For Implantmed SI-1015 only) |
| WH-30185000 | EM-19 Motor, 1.8m Cable, without LED + Port (For Implantmed SI-1015 only) |
| WH-30281000 | EM-19 Motor, 1.8m Cable, without LED + Port (For Implantmed SI-1015 only) |

Terms and Conditions

TERMS AND CONDITIONS OF SALE. The following are the terms and conditions by which Keystone Dental, Inc. sells its products. As used herein, the term “Keystone” means Keystone Dental, Inc. and its applicable affiliates; the term “Products” means the Keystone products and services described in this invoice, and “Purchaser” means the person or company purchasing the Products.

GOVERNING TERMS. Any purchase and shipment of Products shall be deemed to be on the terms and conditions stated herein. Any and all terms and conditions submitted by Purchaser are hereby rejected.

TAXES. The prices set forth herein do not include any sales, use, excise, ad valorem, property or other taxes applicable to the sale, use or delivery of the Products, all of which shall be paid by Purchaser separately or added to the contract price and paid by Purchaser to Keystone.

PRICES. The prices set forth for the Products are in United States Dollars. All prices shall be as of the invoice date, regardless of the date the Product is originally ordered from Keystone.

DELIVERY. Products sold hereunder shall be delivered F.O.B. shipping point. Purchaser shall assume responsibility for all subsequent delivery or shipping charges.

ACCEPTANCE. Purchaser must inspect all Products for defects and/or non-conformity within seven (7) calendar days of delivery. After this period, Purchaser will have accepted such Products.

PAYMENT. Payment terms shall be as set forth on the front of the invoice. If payment is late, the maximum statutory interest rate will apply on such late amount. Keystone may, in its sole discretion, suspend shipments of Products until full payment by Purchaser of all past due amounts to Keystone is made.

RETURN; EXCHANGE. Purchaser may return any Product within thirty (30) calendar days of the invoice date so long as there is an offsetting (exchange) order of equal or greater value. Purchaser may return any Product after thirty (30) calendar days from the invoice date, but no later than ninety (90) calendar days after the invoice date, so long as there is an offsetting (exchange) order of equal or greater value, provided, however, such returns shall be subject to a 15% re-stocking fee. Keystone will not accept any returns or exchanges after ninety (90) calendar days following the invoice date.

No biomaterial products (bone grafting and membrane) will be accepted for return or exchange. No returns or exchanges will be accepted for Products that (i) were originally sold as part of a kit, pack or set, (ii) were included on the original invoice at no charge, (iii) have less than six (6) months remaining before expiration or (iv) were custom ordered. The Purchaser shall pay all shipping costs associated with the return or exchange of a Product. No Products will be accepted by Keystone for return or exchange without an RMA number given to Purchaser by Keystone Customer Service. Returned Products must be unexpired, unopened and undamaged, returned freight prepaid.

WARRANTY. Except as expressly set forth in Keystone’s lifetime implant warranty program, Keystone does not make any warranty, express or implied, except that its products shall be free from defects in material and/or workmanship. This warranty applies only to the original purchaser. Purchaser assumes all risks and liability resulting from the use of these products, whether used separately or in combination with other products. The warranty does not apply if the failure of the product is caused by trauma or accident or by the patient in whom the implant was installed or if the purchaser is not current on all outstanding payments to Keystone at the time of such claim. Keystone may modify or terminate its warranty program at any time, however any changes to the warranty program will not affect products already purchased at the time of such change. Purchaser’s sole remedy with respect to claims related to Keystone products is restricted to the warranty policy.

LIMITATION OF LIABILITY. Under no circumstances shall Keystone or any of its affiliates be liable for business interruption, loss of profits, special, indirect, incidental or consequential damages of any nature and from any cause whether based in contract, warranty or tort (including negligence) or other legal theory, even if Keystone has been advised of the possibility of such damages.

INTELLECTUAL PROPERTY. All intellectual property rights in Products sold to Purchaser shall remain the exclusive property of Keystone and its licensors.

PERSONAL DATA. It is Purchaser’s responsibility to obtain patient’s consent to transfer any personal data to Keystone.

TERMINATION. Keystone may terminate this or any agreement with Purchaser to purchase its products upon immediate written notice if Purchaser fails to pay any of its debt obligations to Keystone on time.

FORCE MAJEURE. Keystone shall not be liable for any loss or damage due to failure or delay arising out of any cause beyond the reasonable control of Keystone. In the event of any failure or delay resulting from such causes, an equitable adjustment of delivery and any other appropriate terms and conditions shall be made. No such failure or delay shall be the basis for an increase in Keystone’s obligations, nor any termination by Purchaser.

VALIDITY. If any provision of these Terms and Conditions is found to be illegal or unenforceable in any respect, such illegality or unenforceability shall not affect any other provision of these Terms and Conditions, all of which shall remain enforceable in accordance with their terms.

GENERAL PROVISIONS. The purchase of the Products and these Terms and Conditions are governed by the laws of the Commonwealth of Massachusetts, without regard to conflicts of law principles. Any dispute, claim or controversy arising out of or in connection with the purchase of the Products shall be resolved by arbitration in Boston, Massachusetts. This document incorporates all oral and written representations between the parties and constitutes the entire agreement and understanding of the parties with respect to the subject matter hereof and supersedes any and all other agreements either oral or written between the parties with respect to such subject matter. No amendment or modification may be made to this document unless in writing and duly executed by an authorized representative of Keystone. Keystone may subcontract, assign or transfer its obligations or rights to a competent third party. Purchaser may not assign or transfer any of its obligations without the consent of Keystone.

Keystone Dental, Inc.
Global Headquarters

154 Middlesex Turnpike
Burlington, MA 01803 USA
Customer Relations: 866-902-9272 or 781-328-3490
Fax: 866-903-9272 or 781-328-3400
Email: info@keystonedental.com
or customersupport@keystonedental.com



Caution, consult accompanying documents

Trademark Acknowledgements

TiLobe, PrimaPlus, Quick-Cap and "Smarter Thinking. Simpler Design." are trademarks and registered trademarks of Keystone Dental, Inc.